

Page cut line. Do not print.

United States  
Department of  
Agriculture

Forest Service

Technology &  
Development  
Program

7100-Engineering  
March 2010  
1071-2812P-MTDC



# Sign Installation Guide

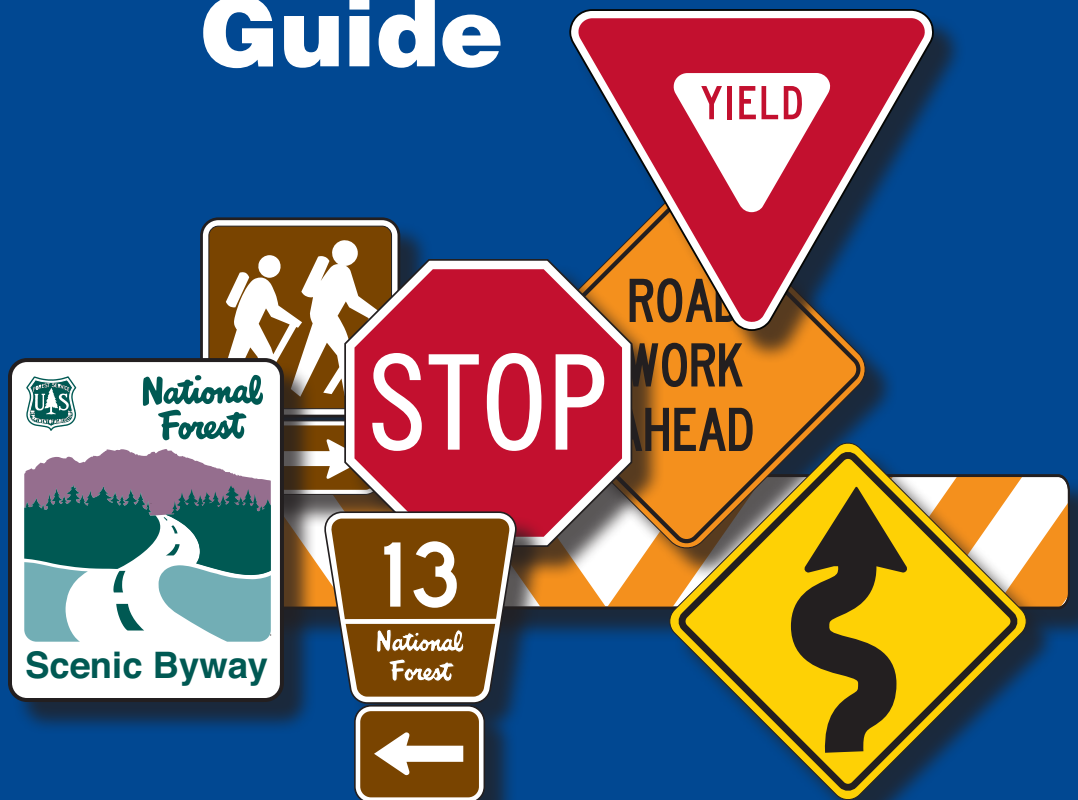

Page cut line. Do not print.

## Notice

This document is disseminated under the sponsorship of the U.S. Department of Transportation in the interest of information exchange. The U.S. Government assumes no liability for the use of information contained in this document.

The U.S. Government does not endorse products or manufacturers. Trademarks or manufacturers' names appear in this report only because they are considered essential to the objective of this document.

The contents of this report reflect the views of the authors, who are responsible for the facts and accuracy of the data presented herein. The contents do not necessarily reflect the official policy of the U.S. Department of Transportation.

This report does not constitute a standard, specification, or regulation.



Page cut line. Do not print.

## Thanks to:

Steve Coupal—R-2      Mike Tippie—R-6  
Fred Ranck—FHWA      Victoria Brinkly—FHWA

This publication is a result of a partnership between the U.S. Department of Agriculture (USDA), Forest Service, Technology and Development Program and the U.S. Department of Transportation, Federal Highway Administration (FHWA), Coordinated Technology Implementation Program (CTIP). CTIP is a cooperative technology deployment and sharing program between the FHWA Federal Lands Highway office and the Federal land management agencies.

The Forest Service, United States Department of Agriculture (USDA), has developed this information for the guidance of its employees, its contractors, and its cooperating Federal and State agencies, and is not responsible for the interpretation or use of this information by anyone except its own employees. The use of trade, firm, or corporation names in this document is for the information and convenience of the reader, and does not constitute an endorsement by the Department of any product or service to the exclusion of others that may be suitable.

The U.S. Department of Agriculture (USDA) prohibits discrimination in all its programs and activities on the basis of race, color, national origin, age, disability, and where applicable, sex, marital status, familial status, parental status, religion, sexual orientation, genetic information, political beliefs, reprisal, or because all or part of an individual's income is derived from any public assistance program. (Not all prohibited bases apply to all programs.) Persons with disabilities who require alternative means for communication of program information (Braille, large print, audiotape, etc.) should contact USDA's TARGET Center at (202) 720-2600 (voice and TDD). To file a complaint of discrimination, write to USDA, Director, Office of Civil Rights, 1400 Independence Avenue, S.W., Washington, D.C. 20250-9410, or call (800) 795-3272 (voice) or (202) 720-6382 (TDD). USDA is an equal opportunity provider and employer.

Page cut line. Do not print.

# Sign Installation Guide



**Donna Sheehy**  
*Traffic Management Engineer*

**Ted J. Cote**  
*Visual Information Specialist*

**USDA Forest Service**  
**Technology and Development Program**  
**Missoula, MT**

**6E62H99—Sign Installation Field Guide**

**March 2010**

---

# Contents

Introduction .....	1
Placement Guidelines .....	2
Breakaway Guidelines for Wood Sign Posts .....	4
Wood Sign Post Spacing and Size Requirements .....	5
Sign Face Orientation Angle .....	6
Sign Decals .....	7
Regulatory Sign Installations .....	8
Warning Sign Installations .....	10
Object and Barricade Marker Installations .....	16
Guide Sign Installations .....	22
Delineator Installations .....	33



Page cut line. Do not print.

## Introduction

It is very important to install standard traffic control signs consistently and correctly. The effectiveness of a sign can be compromised if it is used inappropriately or if it is installed incorrectly. A sign that is confusing, or one that cannot be seen in time, is useless.

This guide contains information needed to install traffic control signs on National Forest System roads in accordance with the “Manual on Uniform Traffic Control Devices” (MUTCD) and EM 7100-15, “Sign and Poster Guidelines for the Forest Service.” The guide provides a visual reference for contractors, volunteers, and Forest Service field personnel who install and maintain signs. A quick check of the guide should ensure far fewer errors in installations.

Before any signs are ordered and installed, this guide assumes that:

- A sign plan has been completed and approved.
- An engineering study or engineering judgment has been used to determine sign needs.
- All traffic control signs, messages, and sizes meet MUTCD and Forest Service standards.

Uniform installation of signs is highly desirable. However, because no two roads are exactly alike, unusual situations may be encountered relating to topography, man-made objects, intermediate intersections, or other circumstances that may require some modifications to typical sign placement guidelines and standards. The most suitable placement of each sign must be determined at the site—where all variables are visible. Any deviations or adjustments should be documented.

State and county sign requirements may vary. Check with local jurisdictions when installing signs on county, State, or Federal roads. The Forest Service has no authority to install signs of any nature within the right-of-way of county, State, or Federal roads without a signed agreement from the authorizing agency.

The guide is not intended to serve as a substitute for training nor does it include every type of sign. Refer to the “Manual on Uniform Traffic Control Devices” (MUTCD) and EM 7100-15, “Sign and Poster Guidelines for the Forest Service,” for complete information.

Page cut line. Do not print.

## Placement Guidelines

Locate signs on the **right side of the road** unless specific standards require otherwise.

Place signs where they are clearly visible and provide adequate time for proper viewer response. Consider factors such as vehicle speed, road conditions, intermediate intersections, sight distance, and alignment. Select locations that minimize viewing obstructions.

### Avoid locations such as:

- Dips in the road
- Just beyond the crest of a hill
- Where a sign could be obscured by other signs or objects
- Where the sign may interfere with the normal use of the road
- Where there is increased need for users to focus on the road
- Where vegetation could cover the sign
- Snow removal and disposal areas

### Certain signs supplement each other and are mounted on the same post, such as:

- A warning sign with an advisory speed plate (page 14)
- Route markers and destination signs (pages 22 to 25)

### Some signs should not be mounted together. Signs with different messages should be erected individually on separate posts, such as:

- A speed limit and a one-way sign
- A curve warning sign and a junction-ahead sign
- A warning sign and a guide sign

## Sign Spreading

Several signs at the same location can overload users with too much information, causing confusion and detracting from critical messages. Signs requiring different decisions should be spaced sufficiently far apart for the required decisions to be made independently and safely. To determine the minimum spread distance between signs, use table 1.

Table 1—Minimum spread distance (distance between signs) for the speed posted. If the speed limit is not posted, an engineering traffic study should be conducted to determine the 85th percentile speed (normally considered the highest safe speed for a section of roadway). The sign spread is based on the 85th percentile speed.

Speed	Minimum Spread Distance
≤ 35 miles per hour	100 feet
> 40 miles per hour	5 x the speed = _____ feet

In situations where two or more signs are needed at about the same location, use the following placement order:

1. Location-critical regulatory signs, such as STOP and YIELD
2. Location-critical warning signs, such as TURN and INTERSECTION
3. Other regulatory or warning signs, such as SPEED LIMIT or LIVESTOCK
4. Route markers and guide signs
5. Other informational signs

## Placement Guidelines (cont.)

### Lateral Offset

Lateral offset is the distance from the edge of the traveled way to the nearest edge of the sign—not the distance to the sign post.

- On conventional roads, use:
  - A **minimum of 12 feet** from the edge of the traveled way
  - Where the shoulder is wider than 6 feet, a minimum of 6 feet from the edge of the shoulder
  - No less than 2 feet where it is impractical to follow a or b
- On roads where signs are placed behind barriers such as curbs or guardrails, use:
  - A **minimum of 2 feet** from the roadside edge of the barrier
- On low-volume roads (fewer than 400 vehicles per day) with no shoulders, use:
  - A **minimum of 12 feet** where terrain and vegetation permit
  - A **minimum of 2 feet** where terrain or vegetation make it impractical to follow a

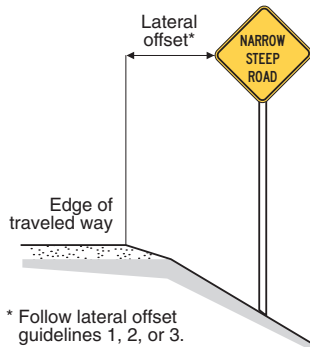

If a sign is installed within the clear zone, a breakaway sign post shall be used (see page 4). The clear zone is the area that ideally would be clear of obstacles that might be a hazard to a vehicle that left the road. The width of the clear area depends on traffic volume, vehicle speed, and the terrain.

### Mounting Height

Mounting height is measured from the road surface to the bottom of the sign.

#### Primary Sign

Use a minimum of 5 feet in:

- Rural areas

Use a minimum of 7 feet in:

- Areas with parking or pedestrians
- Urban, business, commercial, or residential areas
- Areas where the view of the sign may be obstructed

#### Supplemental plaque or sign

Supplemental plaques or signs may be 1 foot lower than the minimum mounting height for the primary sign.

Allow a 1-inch gap between stacked signs so they can expand and contract.

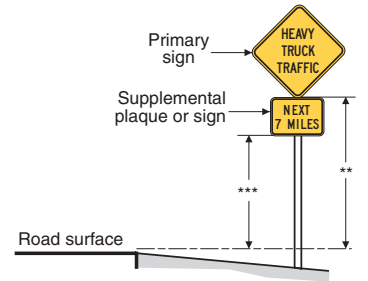

\*\* Mounting height for primary signs  
\*\*\* Mounting height for supplemental plaques or signs

# Breakaway Guidelines for Wood Sign Posts

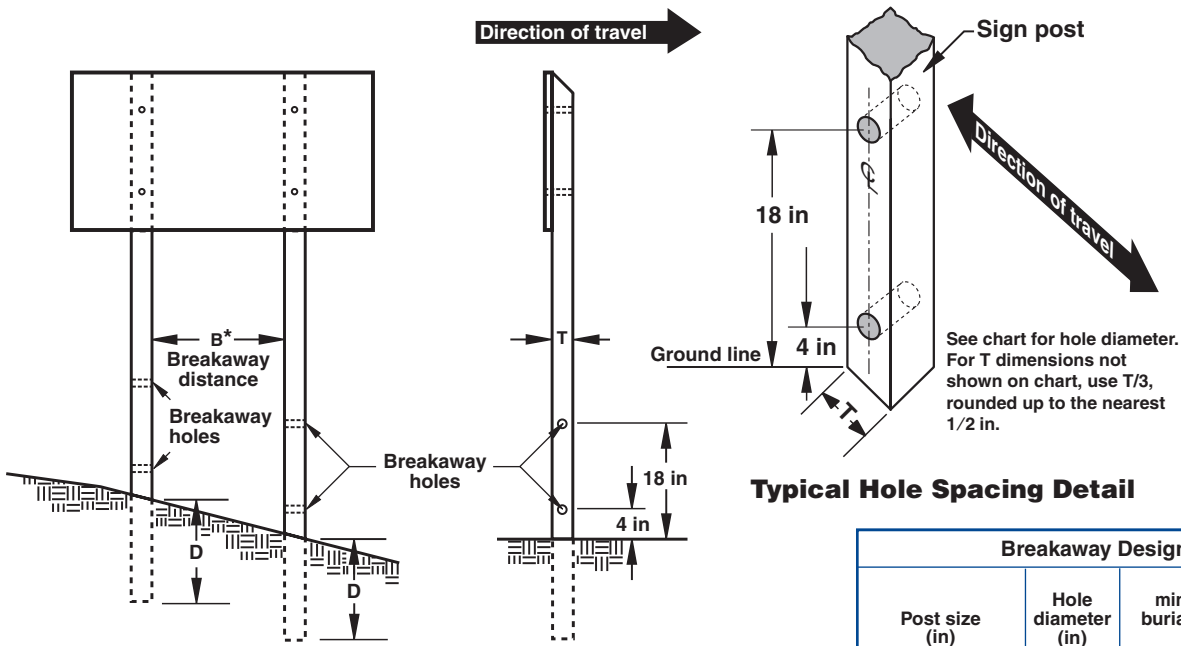

All wood posts 4 x 6 and larger must be modified to meet breakaway requirements if they are within the clear zone.

Breakaway holes must be perpendicular to the direction of vehicle travel.

**Dimension T** is parallel to the direction of vehicle travel and is the larger of the dimensions.

After installing the sign post, drill the breakaway holes and treat holes with preservative.

See chart for hole diameter. For T dimensions not shown on chart, use  $T/3$ , rounded up to the nearest 1/2 in.

**Typical Hole Spacing Detail**

Breakaway Design Requirements			
Post size (in)	Hole diameter (in)	D minimum burial depth (ft)	B minimum breakaway distance (ft)
4 by 4	—	3	—
4 by 6	1.5	4	—
6 by 6	2	4	7
6 by 8	3	4	7

**Typical Breakaway Support**

\*All posts closer than 7 feet from each other act together. Install no more posts than allowed within 7 feet of each other so the combination of posts meets the breakaway guidelines.



Page cut line. Do not print.

## Wood Sign Post Spacing and Size Requirements

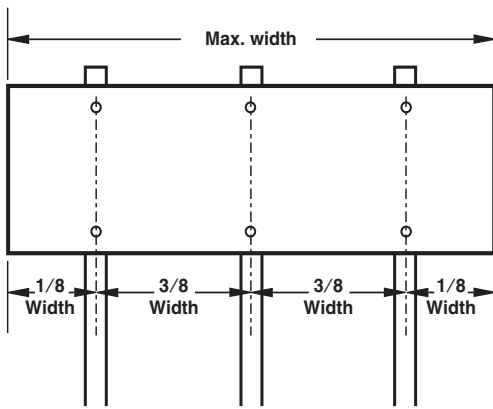

**Three-Post Spacing\***  
(Nonbreakaway installation)

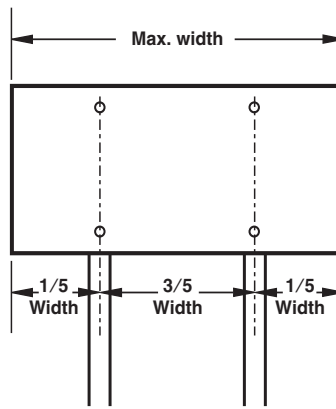

**Two-Post Spacing\***

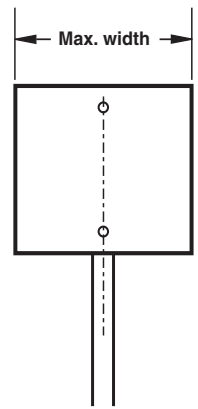

**Single-Post**

\*Post spacing applies to both wood and steel posts.

\*\*For sizes of steel posts, refer to EM 7100-15, chapter 3c.

\*\*\*The maximum width is 36 inches for diamond-shaped signs.

Nonbreakaway sign posts should be installed outside the clear zone, behind a guardrail, or behind a nontraversable ditch.

Post Size** (in)	One post		Two posts		Three posts	
	Max. width (in)	Max. sign area (sq. ft)	Max. width (in)	Max. sign area (sq. ft)	Max. width (in)	Max. sign area (sq. ft)
4 by 4	48***	10	72	20	96	30
4 by 6	48	20	72	50	144	75
6 by 6	48	20	96	95	—	—

Page cut line. Do not print.

Page cut line. Do not print.

## Sign Face Orientation Angle

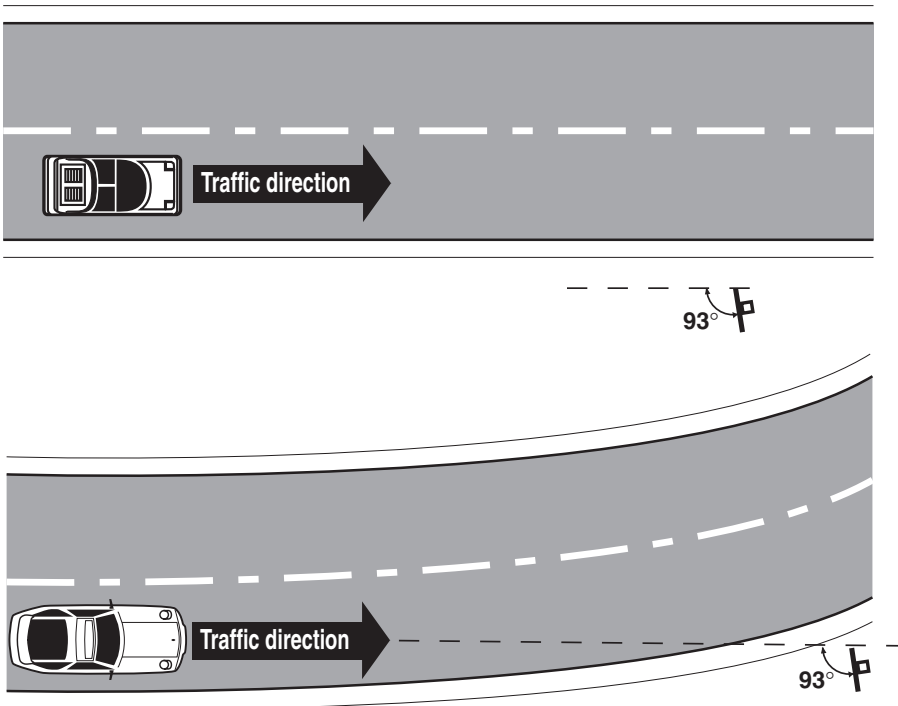

Signs are mounted at approximately right angles to oncoming traffic. It may be necessary to rotate a sign slightly off 90 degrees to avoid glare reflecting off the sign face directly into the driver's eyes.

An angle of about 93 degrees to the line of approaching traffic is recommended.

On curves, orient the sign to face the oncoming traffic—not the road edge.

On steep grades, it may be necessary to tilt the sign forward (uphill grades) or back (downhill grades) to make it easier for motorists to read.

Page cut line. Do not print.

Page cut line. Do not print.

## Sign Decals

When they are first installed, all signs should have the installation date and vandal warning decals attached to the corner of the sign closest to the road.

The vandal warning decal goes on the back of STOP or YIELD signs, but on the front of all other signs. The installation date decal goes on the back of all signs.

Both decals may be obtained from Unicor.

Sign installation date decal

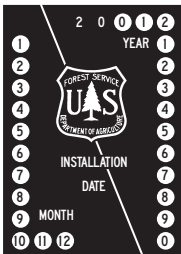

Typical placement of the decal on the back of the sign.

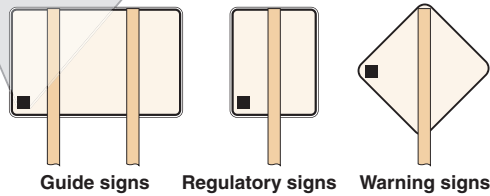

Installation Date Decal

Vandal warning decal

THE WILLFUL DEFACING OR REMOVAL OF FOREST SERVICE NOTICES SUBJECT TO CRIMINAL PROSECUTION WHICH MAY RESULT IN A FINE AND/OR IMPRISONMENT  
1 USC S. 1 1  
\$10,000 FINE AND/OR 10 YEARS

Typical placement on the front of the sign.



**Guide sign**—  
decal has white legend on transparent film



**Regulatory sign**—  
decal has black legend on transparent film



**Warning sign**—  
decal has black legend on transparent film

Vandal Warning Decal

Page cut line. Do not print.

# Regulatory Sign Installations

### Regulatory signs:

- Inform users of traffic laws, regulations, and legal requirements
- Are enforceable
- Are placed at the point where the regulation begins

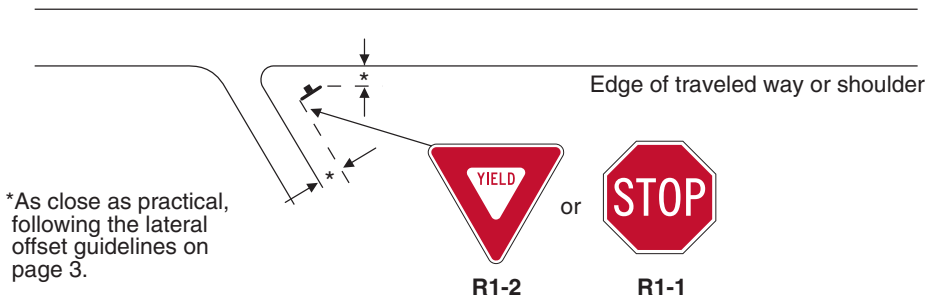

**Yield and Stop Signs**

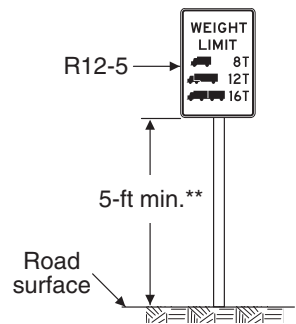

\*\*The 5-foot minimum mounting height applies only in rural areas. See page 3 for the mounting height guidelines that apply in other areas.

### Other Regulatory Signs Used on National Forest System Roads



R2-1



R11-2



R6-1

Page cut line. Do not print.

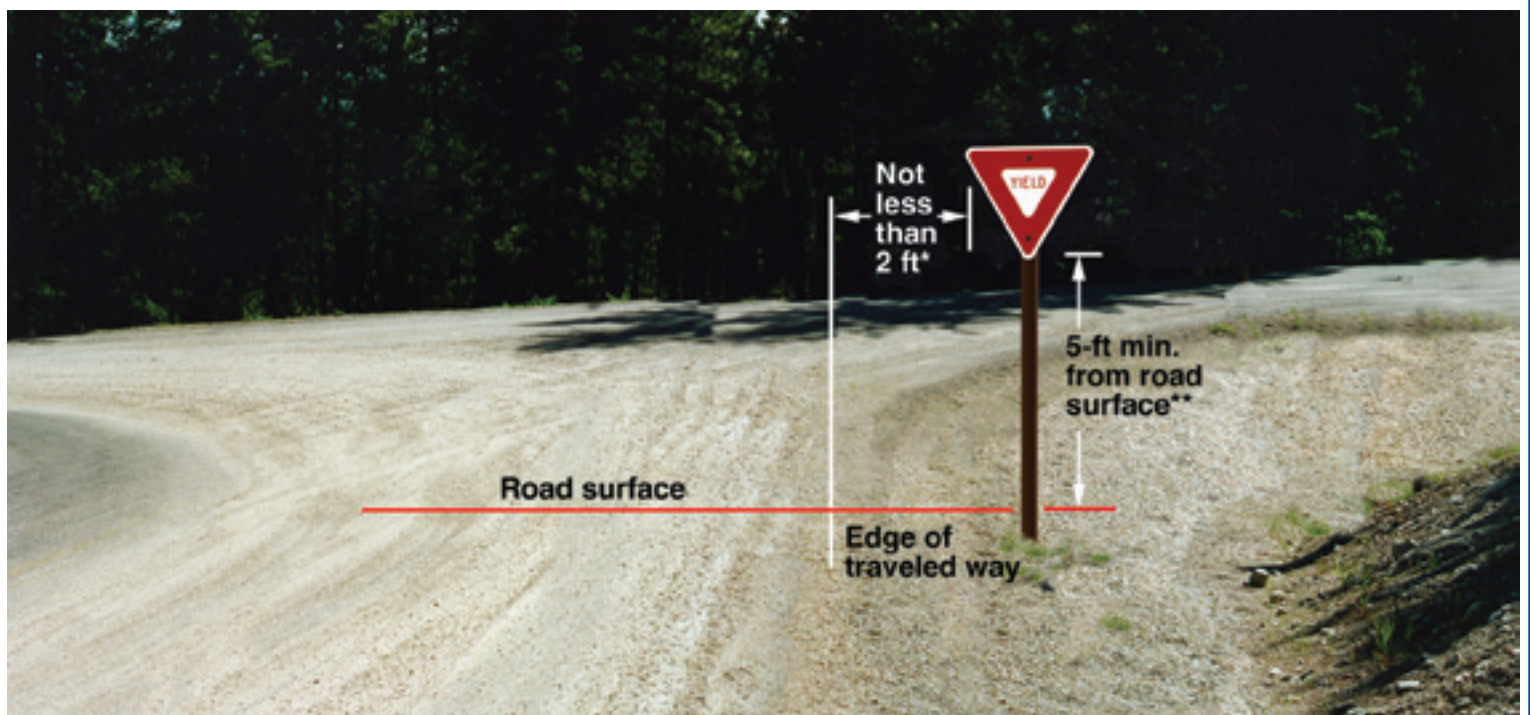

## Regulatory Signs for a Low-Volume Rural Road

\*The 2-foot minimum distance for low-volume roads applies only where terrain or vegetation limit the distance. See page 3 for lateral offset guidelines on other types of roads or where terrain and vegetation are not factors.

\*\*The 5-foot minimum mounting height applies only in rural areas. See page 3 for the mounting height guidelines that apply in other areas.

Page cut line. Do not print.

## Warning Sign Installations

### Warning signs:

- Warn drivers of unexpected conditions or situations
- Indicate need for caution
- May call for reduced speed or an unexpected vehicle maneuver
- Are placed in advance of the situation to allow adequate time for proper response considering approach speed, road conditions, intermediate intersections, and other factors as shown in table 2 on page 11

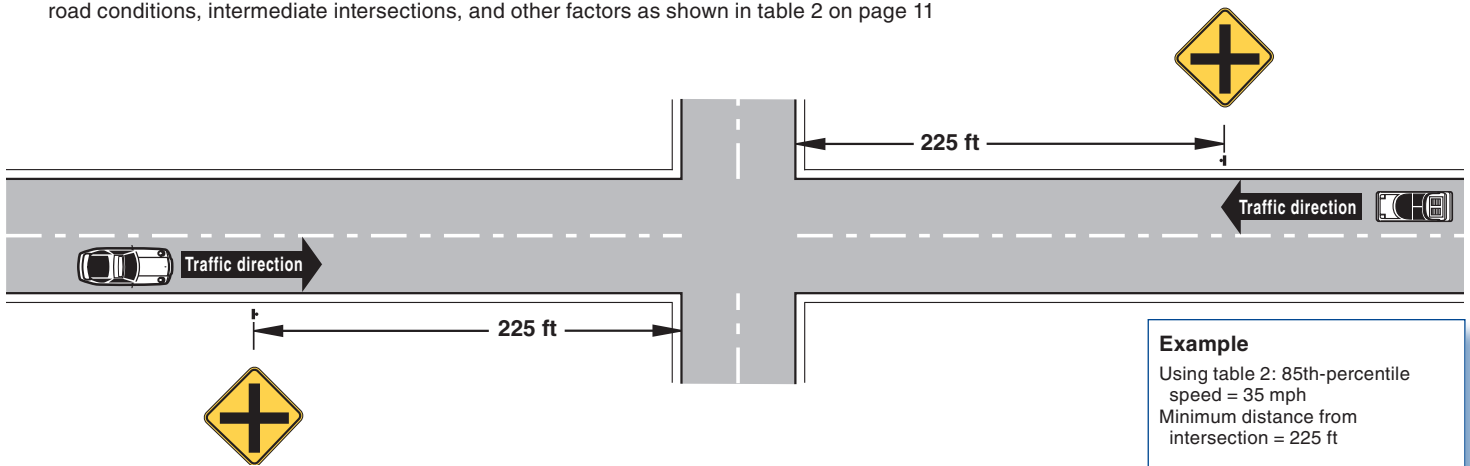

### Example

Using table 2: 85th-percentile speed = 35 mph  
Minimum distance from intersection = 225 ft

### Advance Warning Sign Placement Distances

10

## Warning Sign Installations (cont.)

### Minimum Advance Placement Distances

Table 2—Advance warning sign placement distances for **unpaved low-volume roads**.

Posted speed or 85th-percentile speed (mph)	Stopping sight distance (ft)	Distance for deceleration (feet) to advisory speed listed (mph)				Additional distance (feet) on downgrade (percent)			
		10	20	30	40	3	6	9	12
		(ft)				(ft)			
20	115	125	—	—	—	5	10	20	30
25	155	150	—	—	—	8	15	30	45
30	200	200	150	—	—	10	20	45	65
35	250	250	225	—	—	15	35	60	90
40	305	325	300	275	—	20	45	75	120
45	360	400	350	300	—	25	55	95	150
50	425	475	450	375	275	30	70	120	185
55	495	550	525	450	350	35	85	145	225

- These minimum distances may be exceeded when necessary.
- Distance for deceleration is the minimum distance a warning sign should be placed in advance of a condition.
- Sign placement distances are based on sign legibility for 24-inch signs and 4-inch letters.
- If larger signs are used, evaluate the placement distances as part of the engineering study or use engineering judgment to determine

- whether the placement distances may be reduced. Document calculations and rationale.
- Distances are for level roadways. Increase placement distance on downgrades of 3 percent or steeper.
- Placement distances on upgrades may be reduced by one-half the distances listed for downgrades.
- On conventional roads and paved low-volume roads (fewer than 400 vehicles per day), use the MUTCD.

## Warning Sign Installations (cont.)

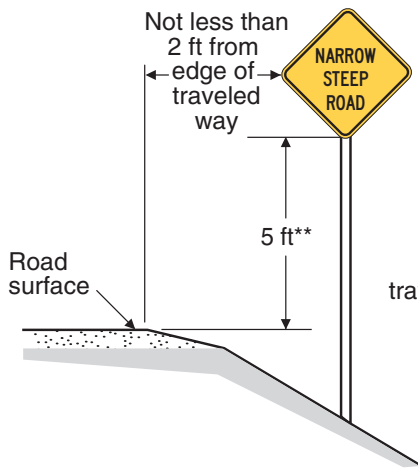

**Low-Volume Rural Roads  
Where Terrain or Vegetation  
Limit the Lateral Offset**

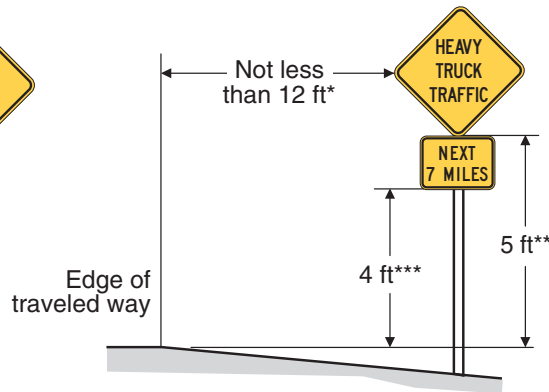

**All Rural Roads—  
Standard Placement**

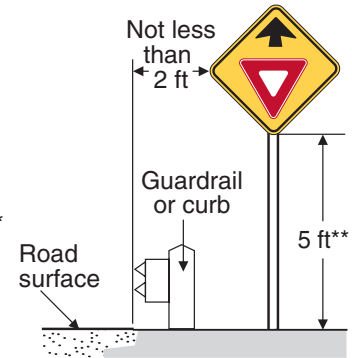

**Rural Low-Volume and  
Conventional Roads**

\*See page 3 for lateral offset guidelines that apply to roads with shoulders or where the 12-foot minimum is not practical.  
\*\*The 5-foot minimum mounting height applies only in rural areas. See page 3 for the mounting height guidelines that apply in other areas.  
\*\*\*See page 3 for the mounting height of supplemental plaques or signs and for the recommended gap between stacked signs.

### Lateral Offset and Mounting Height for Warning Signs





### Warning Sign for Low-Volume Rural Roads (no supplemental plaques)

\*The 2-ft minimum distance for low-volume roads applies only where terrain or vegetation limit the distance. See page 3 for lateral offset guidelines on other types of roads or where terrain and vegetation are not factors.

\*\*The 5-foot minimum mounting height applies only in rural areas. See page 3 for the mounting height guidelines that apply in other areas.

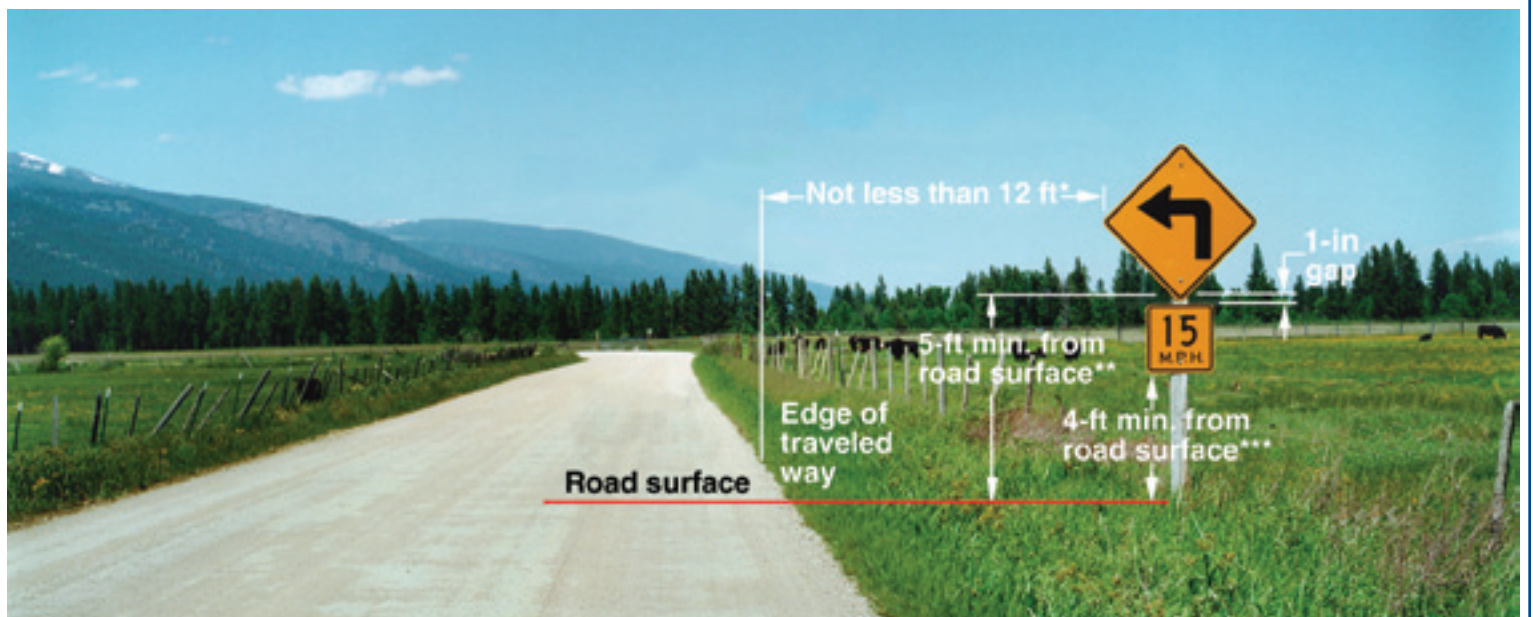

## Warning Sign With Advisory Speed Plate for a Conventional or Low-Volume Rural Road

Advisory speed plates supplement the warning sign and shall not be used alone.

\*See page 3 for lateral offset guidelines on other types of roads or where terrain or vegetation limit the distance.

\*\*The 5-foot minimum mounting height applies only in rural areas. See page 3 for the mounting height guidelines that apply in other areas.

\*\*\*See page 3 for the mounting height of supplemental plaques or signs.

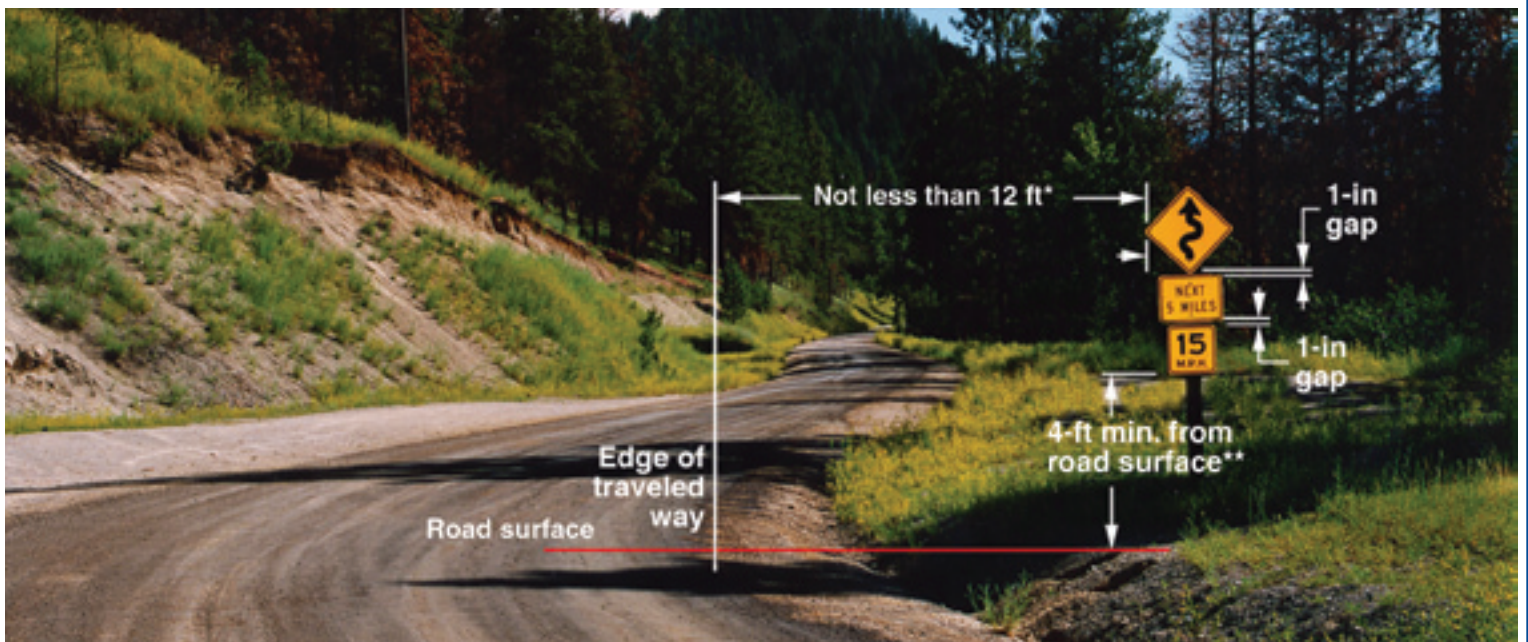

## Warning Sign With Advisory Speed Plate and Supplemental Plaque for Conventional or Low-Volume Rural Roads

Advisory speed plates and supplemental plaques are not to be used alone. They shall be used only to supplement a warning sign.

\*\*See page 3 for the mounting height of supplemental plaques or signs.

\*See page 3 for lateral offset guidelines on other types of roads or where terrain or vegetation limit the distance.

## Object and Barricade Marker Installations

Type 3 object markers are used to mark objects that intrude into or constrict the roadway.

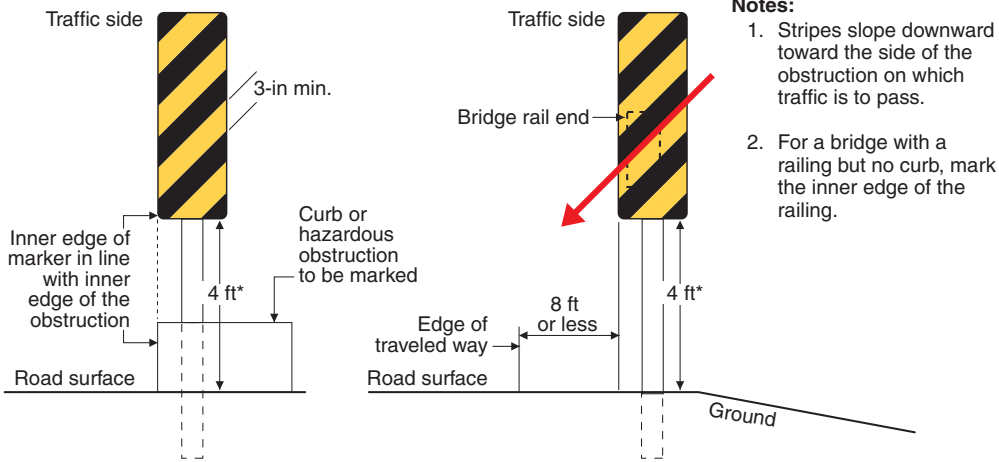

### Notes:

1. Stripes slope downward toward the side of the obstruction on which traffic is to pass.
2. For a bridge with a railing but no curb, mark the inner edge of the railing.

\*Vertical mounting height may vary according to need. Mounting height is normally 4 feet, but shall be no less than 6 inches.

### Placement of Type 3 Object Markers

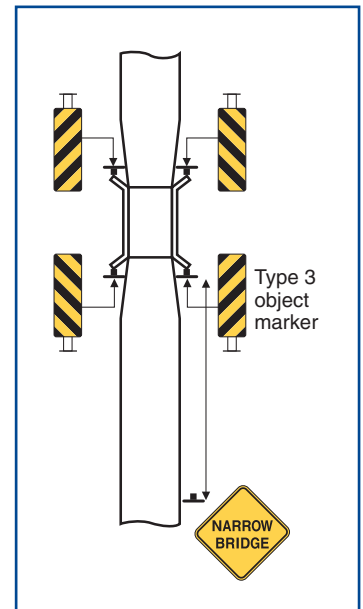

### Single-Lane Road With Narrow Bridge

Page cut line. Do not print.

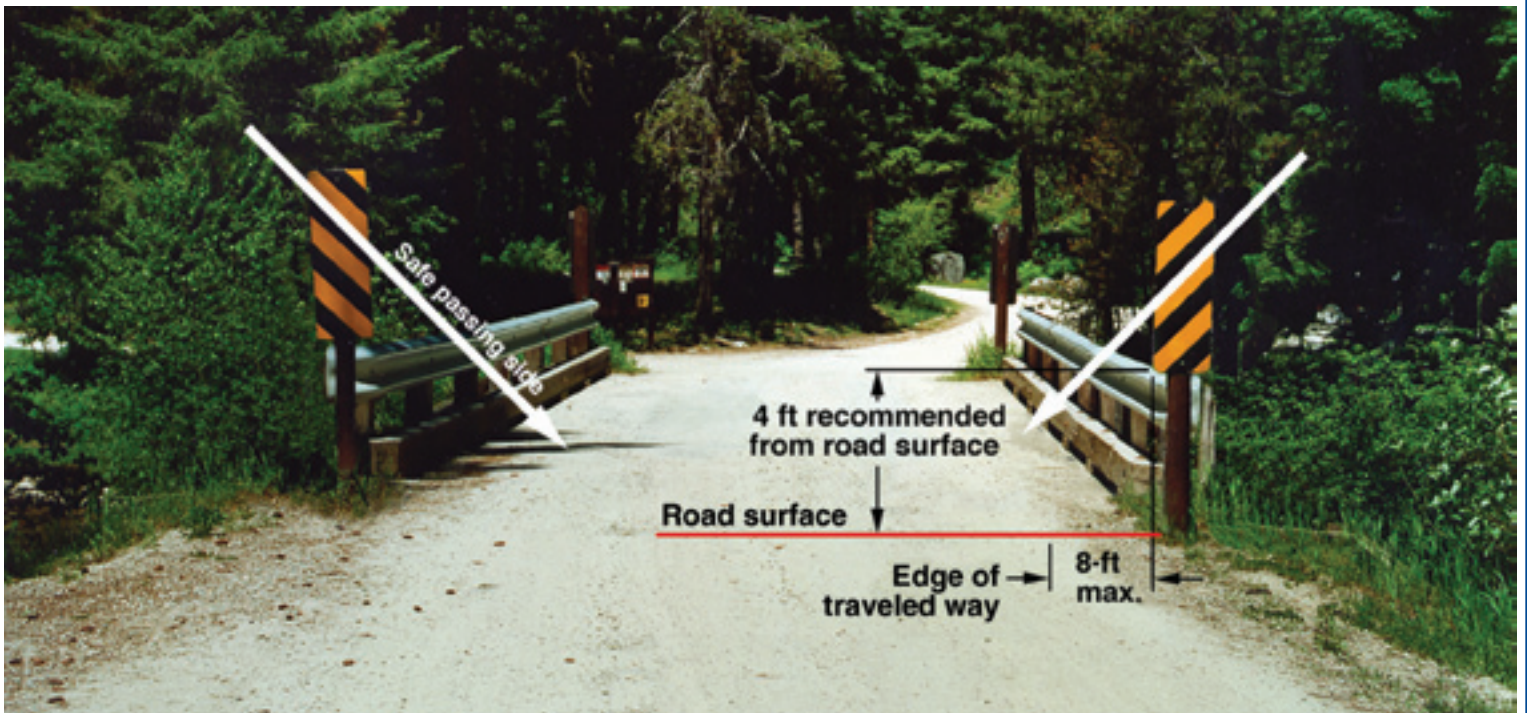

### **Bridge Signing With Type 3 Object Markers (to mark objects that intrude into or constrict the roadway)**

Option: Type 1 object markers also may be used to mark objects that intrude into or constrict the roadway. For a bridge with a railing but no curb, mark the inner edge of the railing.



Page cut line. Do not print.

Page cut line. Do not print.

## Type 2 Object Marker Installations

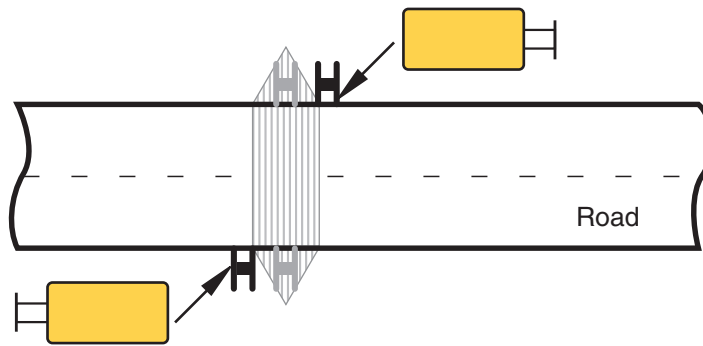
Type 2 Object Markers are used to mark objects that are outside the roadway, but close enough to present a hazard. For narrow objects, such as cattleguards, object markers may be mounted back to back on the same post.



 Alternate location     Object markers mounted back to back



Modified Type 2  
Object Marker

### Object Marker Locations on a Cattleguard

Page cut line. Do not print.

Page cut line. Do not print.



### Cattleguard Signing With Type 2 Object Markers (roadway is not constricted)

\*Vertical mounting height may vary when an object requires a lower or higher mounting. Mount at least 6 inches above the road surface.

Inner edge of marker in line with inner edge of the obstruction.

Page cut line. Do not print.

Page cut line. Do not print.

## Gate Sign Installation

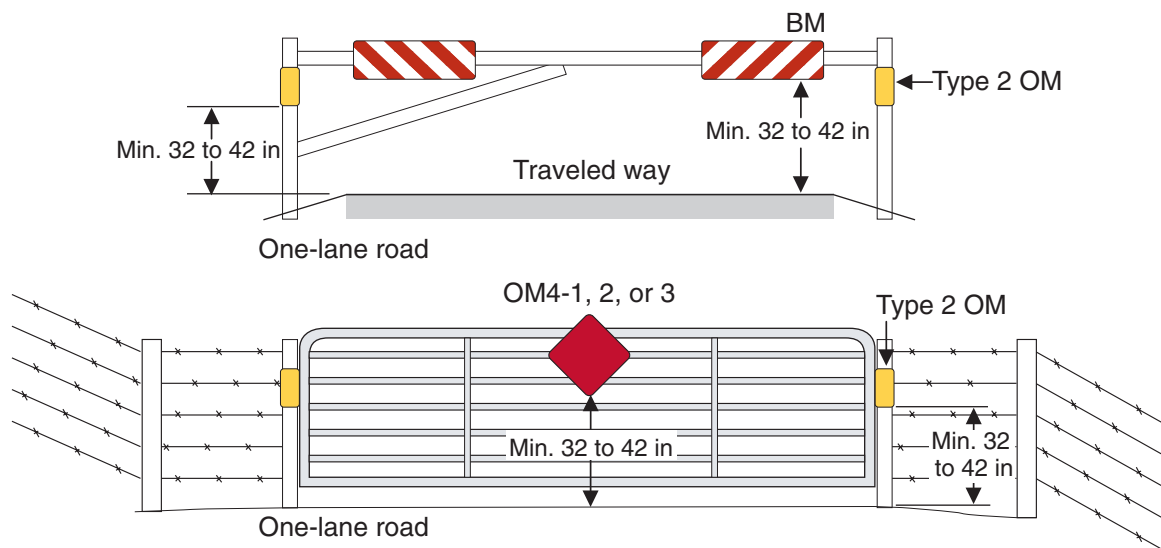

### Barricade Markers (BM), Type 2 Object Markers (OM), and End-of-Roadway Markers (OM4-1, 2, or 3) Used on Gates

If motorized or nonmotorized use (such as bicycles) occurs behind a gate, the back side may require signing also. The size of barricade markers depends on approach speeds.

Page cut line. Do not print.



Page cut line. Do not print.



**Gate Signing With Object Markers (OM) for One-Lane Roads**

Page cut line. Do not print.

## Guide Sign Installations

### Guide signs:

- Are placed ahead of the intersection
- Provide guidance

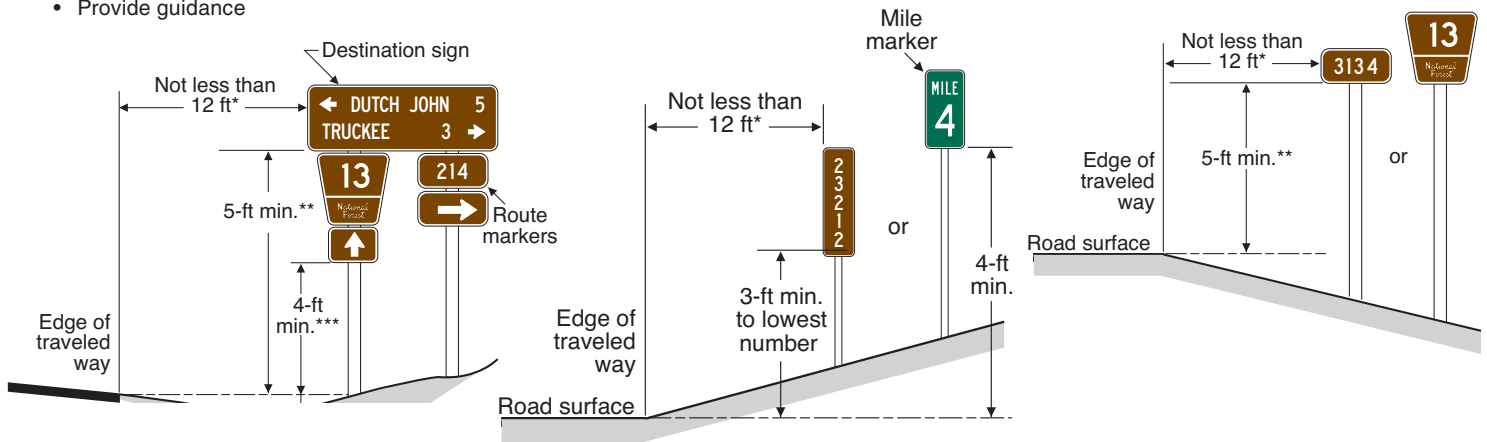

\*See page 3 for lateral offset guidelines that apply to roads with shoulders or where the 12-foot minimum is not practical.

\*\*The 5-foot minimum mounting height applies only in rural areas. See page 3 for the mounting height guidelines that apply in other areas.

\*\*\*See page 3 for the mounting height of supplemental plaques or signs and for the recommended gap between stacked signs.

### Lateral Placement and Mounting Height for Guide Signs

## Guide Sign Installations (cont.)

Table 3—Advance placement of guide signs at intersections. Speeds are rounded off to the nearest 5-miles per hour.

Speed limit or 85th-percentile speed (mph)	Maintenance level 3, 4, 5 roads (ft)	Maintenance level 2 roads and roads within administrative or recreation sites
Under 15	At or near intersection	At or near intersection
15 to 25	100	At or near intersection
30 to 40	100 to 200	—
45 and higher	200 minimum	—

**Example using table 3 for a maintenance level 4 road:**  
 85th-percentile speed = 45 mph  
 Road maintenance level = 4  
 Min. distance = 200 ft

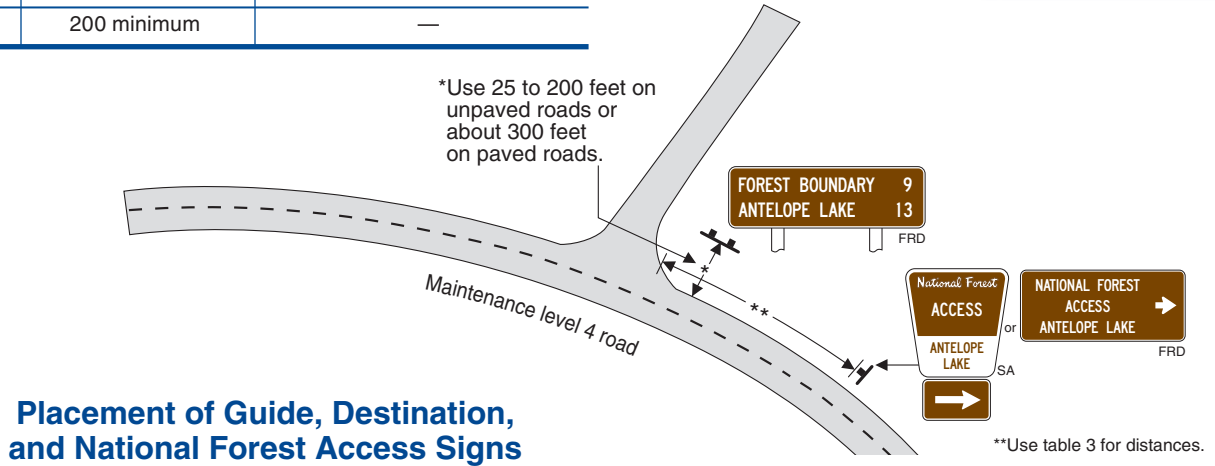

## Guide Sign Installations (cont.)

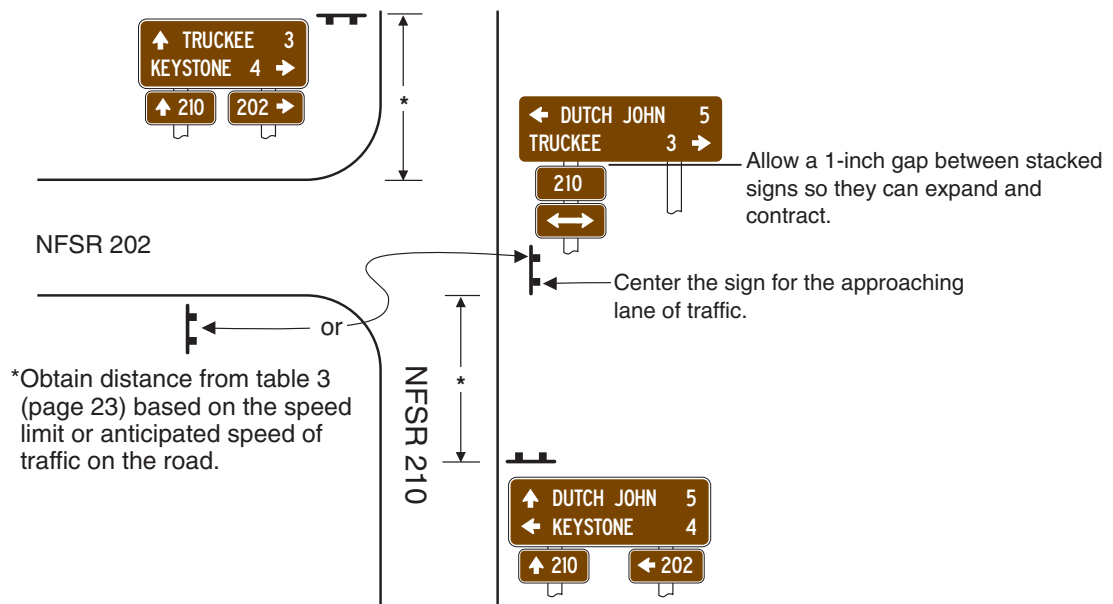

Placement for Destination Signs

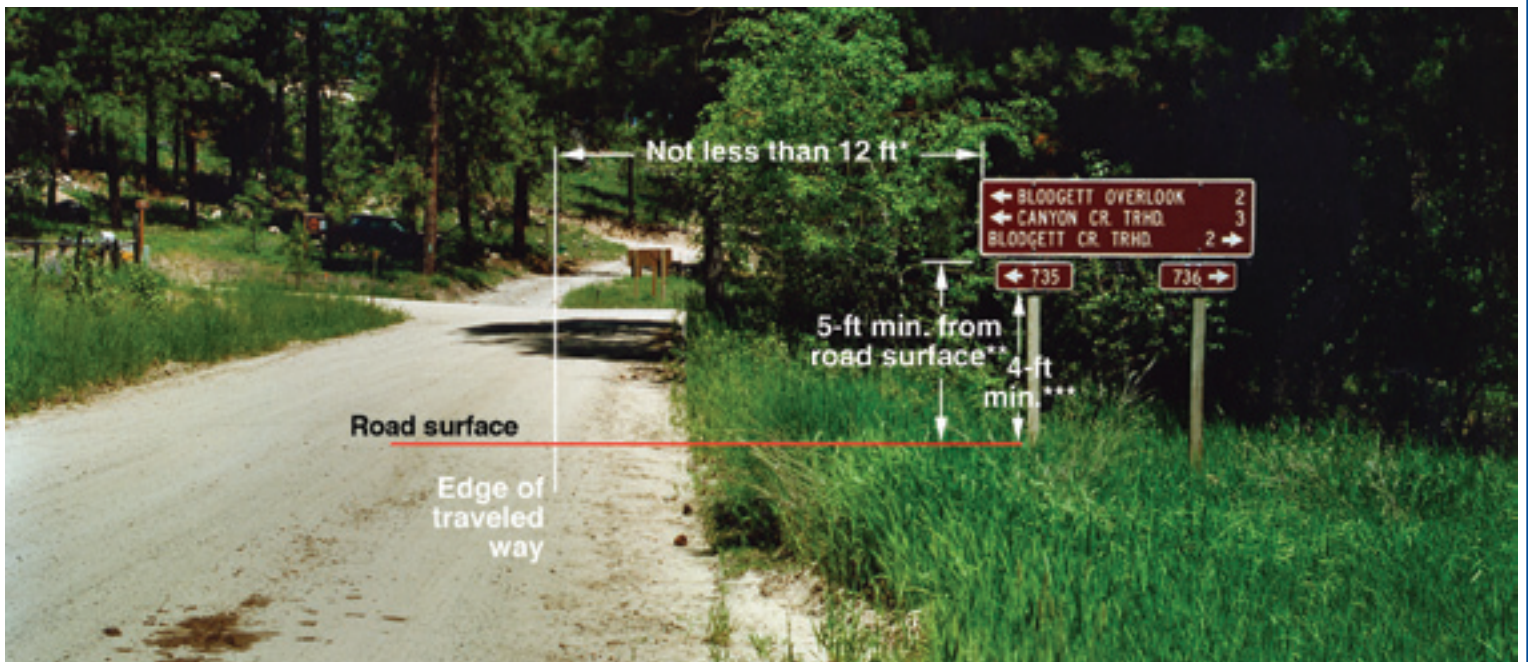

## Destination Sign With Route Markers for Conventional and Low-Volume Rural Roads

\*See page 3 for lateral offset guidelines on other types of roads or where terrain or vegetation limit the distance.

\*\*The 5-foot minimum mounting height applies only in rural areas. See page 3 for the mounting height guidelines that apply in other areas.

\*\*\*See page 3 for the mounting height of supplemental plaques or signs and for the recommended gap between stacked signs.

## Guide Sign Installations (cont.)

### Installation of Route Markers

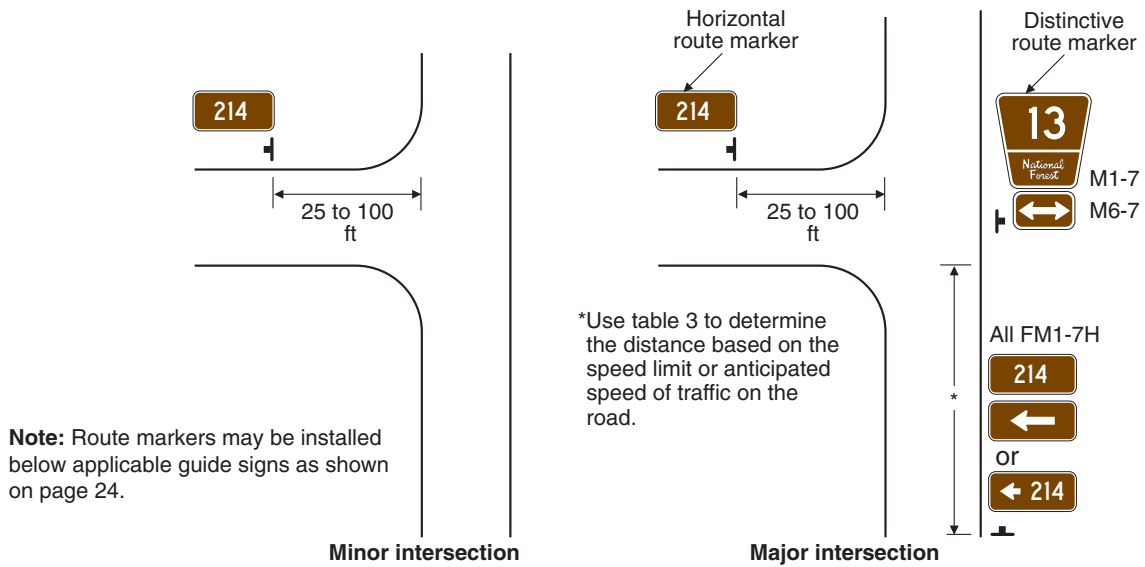

### Locations for Distinctive and Horizontal Route Markers for Maintenance Level 3, 4, and 5 Roads

Page cut line. Do not print.



## Horizontal or Distinctive Route Marker on Low-Volume Rural Roads

\*The 2-ft minimum distance for low-volume roads applies only where terrain or vegetation limit the distance. See page 3 for lateral offset guidelines on other types of roads or where terrain and vegetation are not factors.

\*\*The 5-foot minimum mounting height applies only in rural areas. See page 3 for the mounting height guidelines that apply in other areas.

Page cut line. Do not print.

## Guide Sign Installations (cont.)

### Installation of Vertical Route Markers

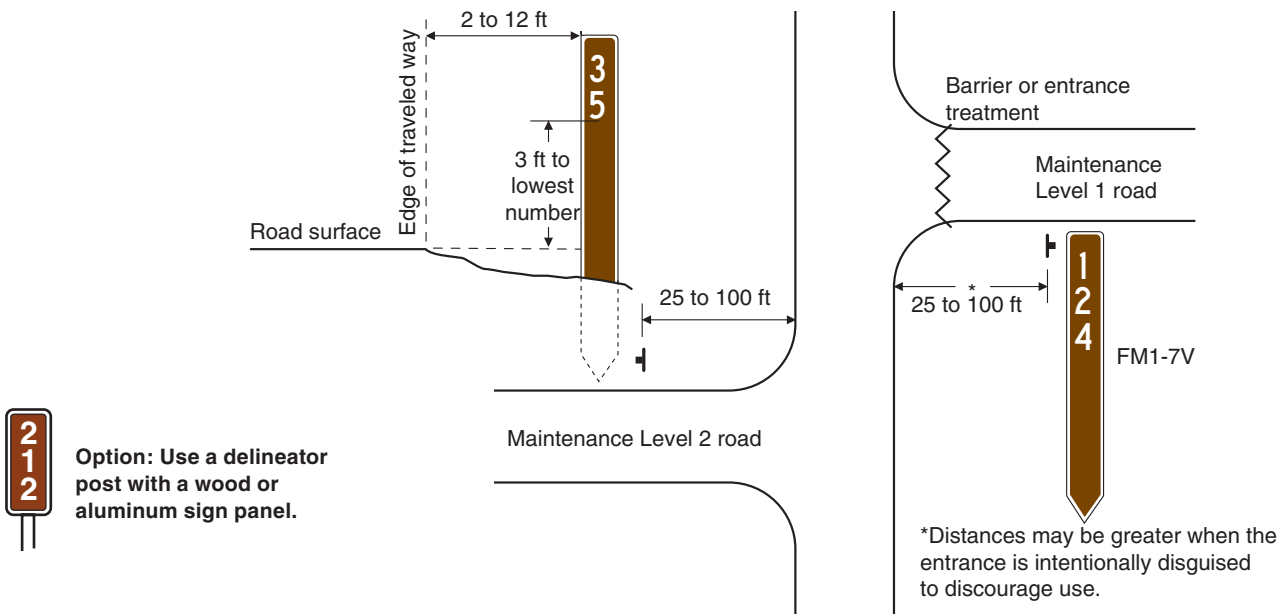

### Locations for Vertical Route Markers on Maintenance Level 1 and 2 Roads



Page cut line. Do not print.

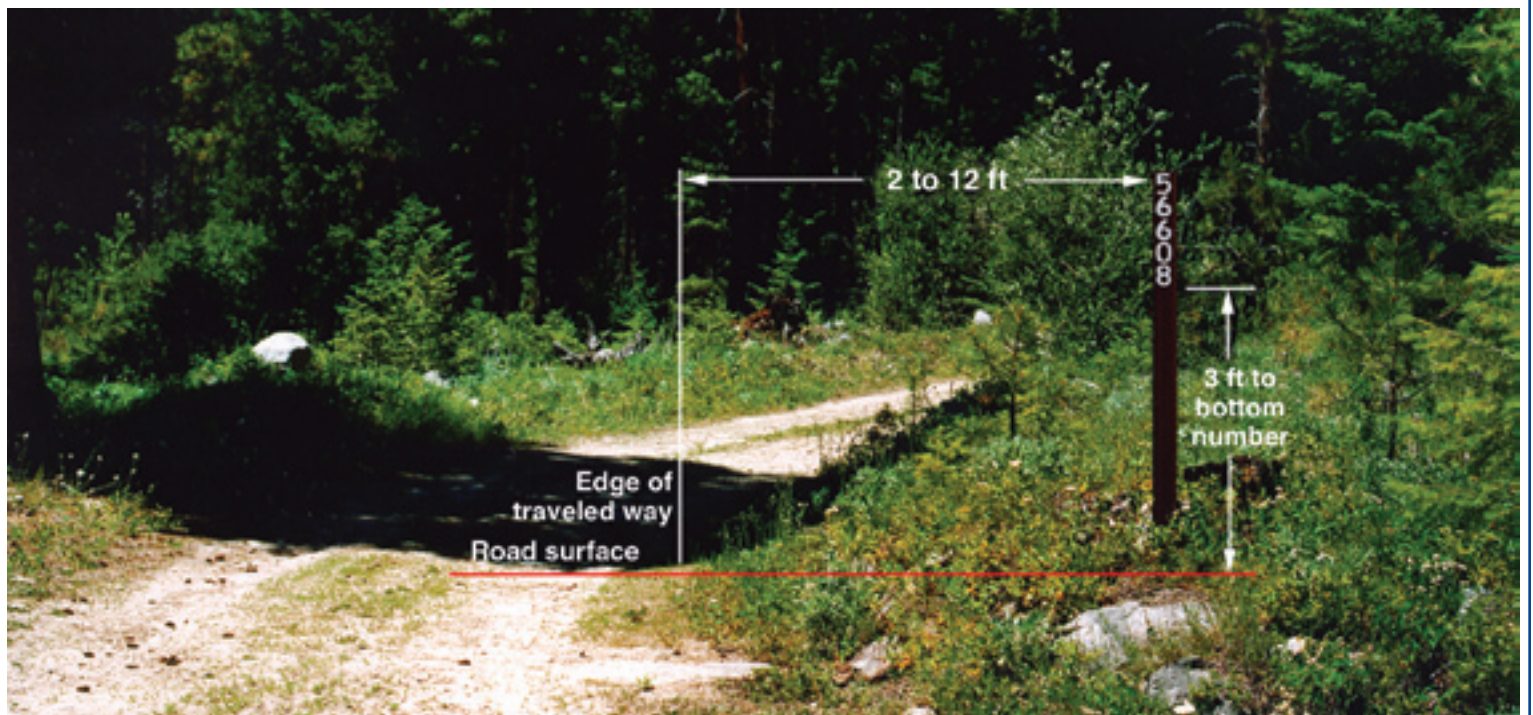

**Vertical Route Marker for Maintenance Level 1 and 2 Roads**

Page cut line. Do not print.

Page cut line. Do not print.

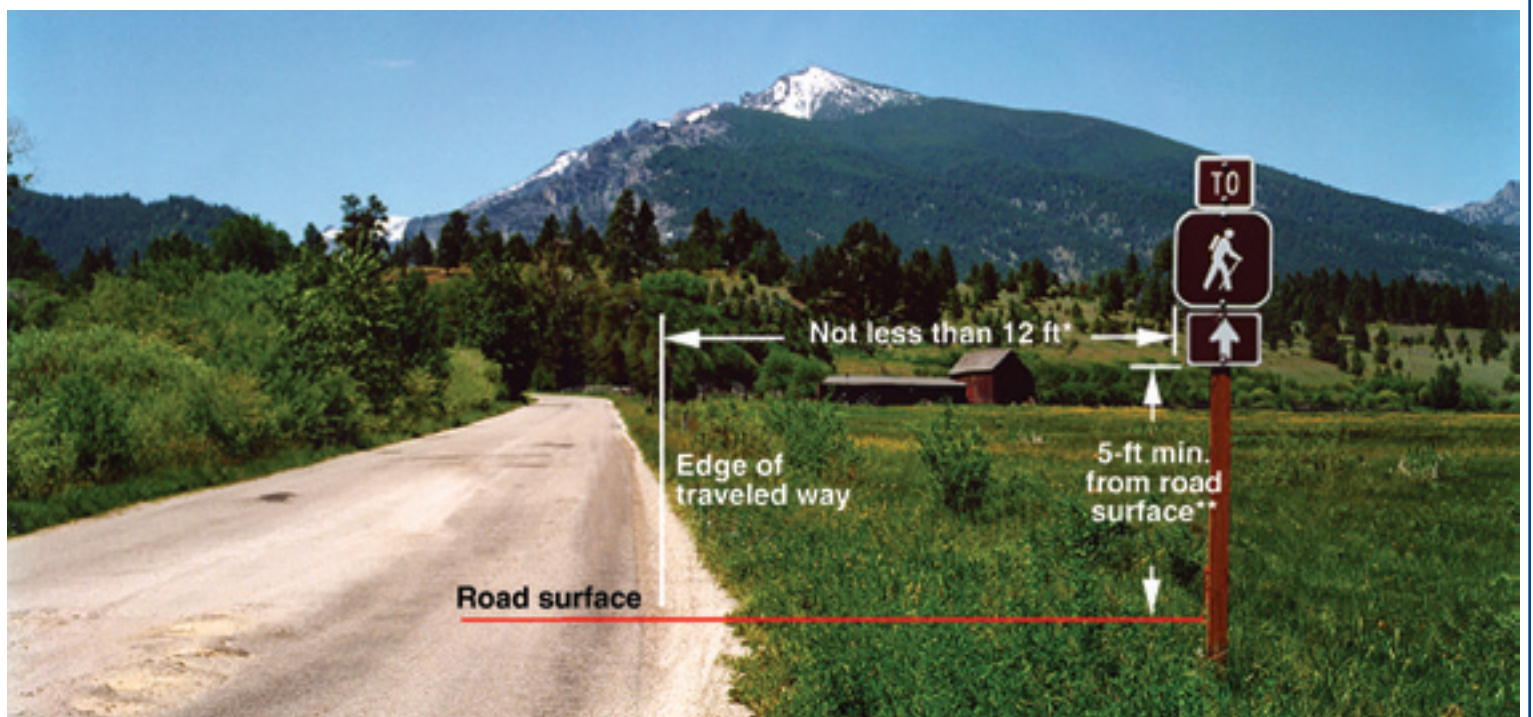

## Trailblazer Assembly for Conventional or Low-Volume Rural Roads

\*See page 3 for lateral offset guidelines on other types of roads or where terrain or vegetation limit the distance.

\*\*The 5-foot minimum mounting height applies only in rural areas. See page 3 for the mounting height guidelines that apply in other areas.

Page cut line. Do not print.

Page cut line. Do not print.

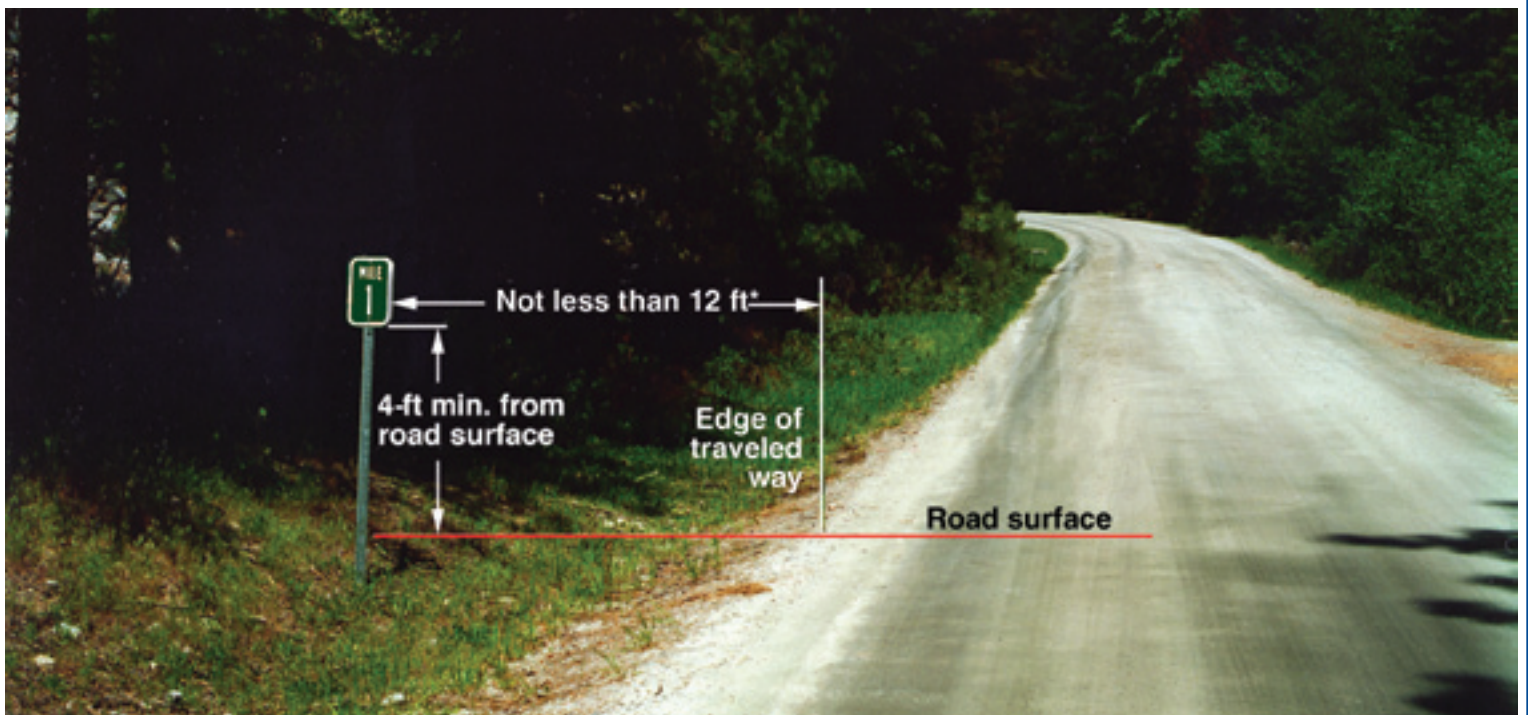

## Milepost Marker for Conventional or Low-Volume Rural Roads

\*See page 3 for lateral offset guidelines on other types of roads or where terrain or vegetation limit the distance.

Page cut line. Do not print.



## Federal Recreation Symbol Assembly for Conventional or Low-Volume Rural Roads

Generally, no more than four symbols should be mounted on a single sign assembly.

\*See page 3 for lateral offset guidelines on other types of roads or where terrain or vegetation limit the distance.

\*\*The 5-foot minimum mounting height applies only in rural areas. See page 3 for the mounting height guidelines that apply in other areas.

## Delineator Installations

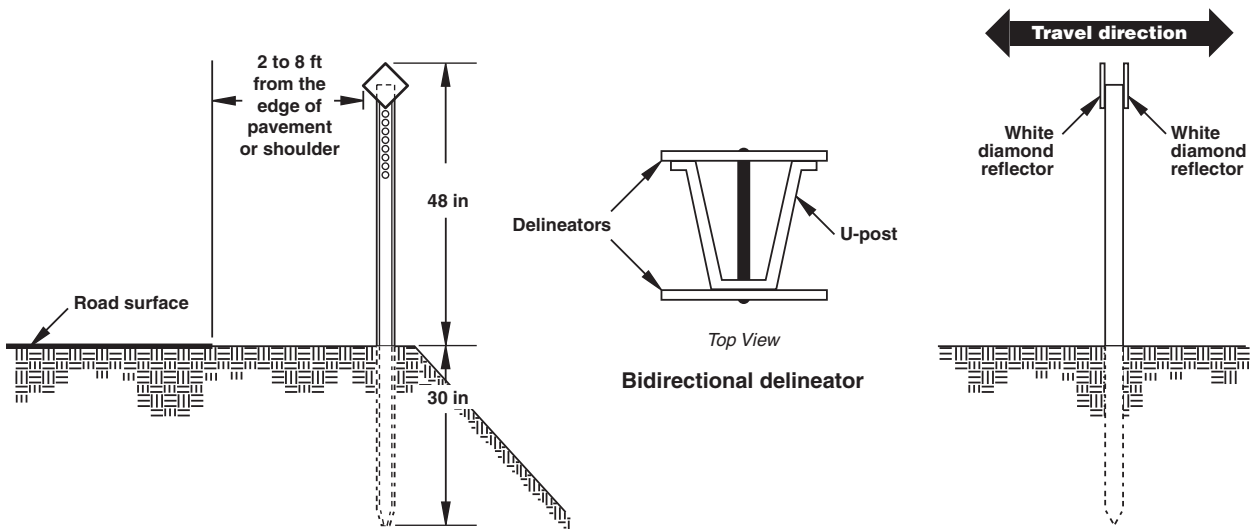

### Notes:

1. Colors (as viewed by driver) on two-way roads, including single-lane roads, are white on both sides of the road. On one-way roads, colors are white on the right and yellow on the left side of the road. (From MUTCD Section 3D.03)
2. Delineator posts may be galvanized steel U-posts, 1.12 pounds per linear foot, 6.5 feet long, or flexible fiberglass posts.
3. Reflectors may be fastened to posts using rivets or other suitable, nonremovable fasteners.
4. The delineators shall be 4- by 4-inch (silver) crystal on both sides, Type 3 retroreflective sheeting. The delineator housing shall be the bidirectional type.

## Delineator Installations (cont.)

### Positioning and Spacing

Operating speed (mph)	Approx. curve radius (ft)	On-curve spacing (ft) S	Spacing before and after curve (ft)		
			A	B	C
20	100	25	50	75	150
30	250	40	80	120	240
40	500	65	130	195	300
50	800	80	160	240	300
60	1,000	90	180	270	300

**Notes:**

1. Prorate distance "x" among all spacings so the last delineator falls on the end of the curve.
2. Install delineators perpendicular to oncoming traffic.

When engineering judgment indicates a need, the figure below shows the position and spacing of delineators for curves on low-volume roads.

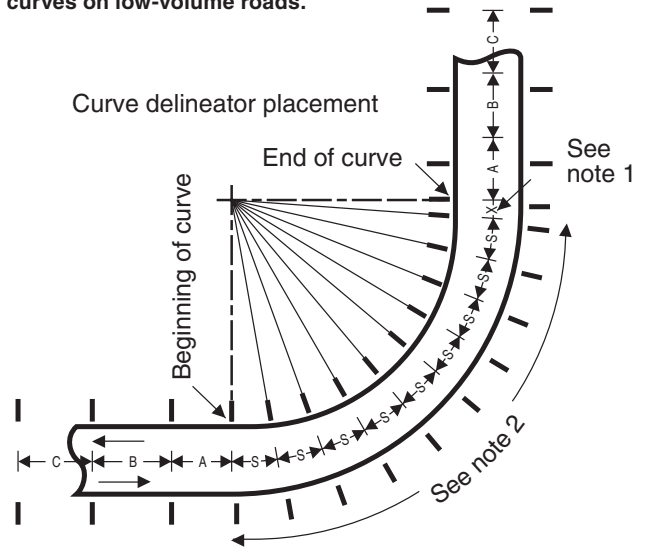

**Delineator Placement and Spacing on Curves**

Page cut line. Do not print.

### **Library Card**

Sheehy, Donna; Cote, Ted. 2010. Sign installation guide. Tech. Rep. 1071–2812P–MTDC. Missoula, MT: U.S. Department of Agriculture, Forest Service, Missoula Technology and Development Center. 35 p.

This guide shows how regulatory, warning, and guide signs are properly mounted and installed on roads. It includes drawings and photographs showing the specifications for placing signs along Forest Service roads and is intended to help new employees or volunteers install road signs.

The guide is based on standards established by the Manual on Uniform Traffic Control Devices and the Sign and Poster Guidelines for the Forest Service (EM-7100-15).

**Keywords:** road signs, specifications, standards, traffic control devices, traffic safety, volunteers

Page cut line. Do not print.

Page cut line. Do not print.



Page cut line. Do not print.